

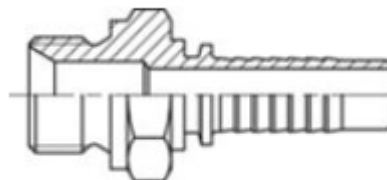

Hydraulic DKOR and AGR BSP threaded fittings

Cone - 60°

Standard - BS 5200

* - not stock

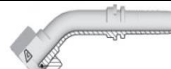

BSP thread		Hose inner diameter			Fitting code			
					P010	P014	P019	P120
in	dash	mm	in	dash				
1/8	02	4,8	3/16	03	P010-02-03*	P014-02-03*	P019-02-03*	P120-02-03*
		6,4	1/4	04	P010-02-04*	P014-02-04*	P019-02-04*	P120-02-04
1/4	04	4,8	3/16	03	P010-04-03*	P014-04-03*	P019-04-03*	P120-04-03*
		6,4	1/4	04	P010-04	P014-04	P019-04	P120-04
		7,9	5/16	05	P010-04-05	P014-04-05*	P019-04-05*	P120-04-05*
		9,5	3/8	06	P010-04-06	P014-04-06*	P019-04-06*	P120-04-06*
3/8	06	6,4	1/4	04	P010-06-04	P014-06-04	P019-06-04	P120-06-04
		7,9	5/16	05	P010-06-05	P014-06-05	P019-06-05	P120-06-05
		9,5	3/8	06	P010-06	P014-06	P019-06	P120-06
		12,7	1/2	08	P010-06-08	P014-06-08*	P019-06-08*	P120-06-08*
1/2	08	6,4	1/4	04	P010-08-04	P014-08-04*	P019-08-04*	P120-08-04*
		7,9	5/16	05	P010-08-05*	P014-08-05*	P019-08-05*	P120-08-05
		9,5	3/8	06	P010-08-06	P014-08-06	P019-08-06	P120-08-06
		12,7	1/2	08	P010-08	P014-08	P019-08	P120-08
		15,9	5/8	10	P010-08-10	P014-08-10*	P019-08-10*	P120-08-10
5/8	10	12,7	1/2	08	P010-10-08*	P014-10-08*	P019-10-08*	P120-10-08*
		15,9	5/8	10	P010-10	P014-10	P019-10	P120-10
3/4	12	12,7	1/2	08	P010-12-08	P014-12-08*	P019-12-08	P120-12-08
		15,9	5/8	10	P010-12-10	P014-12-10	P019-12-10	P120-12-10
		19	3/4	12	P010-12	P014-12	P019-12	P120-12
1	16	19	3/4	12	P010-16-12	P014-16-12*	P019-16-12	P120-16-12
		25,4	1	16	P010-16	P014-16	P019-16	P120-16
1 1/4	20	25,4	1	16	P010-20-16	P014-20-16*	P019-20-16	P120-20-16
		31,8	1 1/4	20	P010-20	P014-20	P019-20	P120-20
1 1/2	24	31,8	1 1/4	20	P010-24-20*	P014-24-20*	P019-24-20*	P120-24-20*
		38,1	1 1/2	24	P010-24	P014-24	P019-24	P120-24
2	32	38,1	1 1/2	24	P010-32-24*	P014-32-24*	P019-32-24*	P120-32-24*
		50,8	2	32	P010-32	P014-32	P019-32	P120-32

ALYTUS • Ulonų g. 33, LT-62161 Alytus, tel. 8-315-75075, tel. 8-315-51824 (parduotuvė), faks. 8-315-73076, el.p.: info@hidrobalt.lt

KLAIPĖDA • Dubysos g. 25, LT-91181 Klaipėda, tel. 8-46-344480, faks. 8-46-345976, klaipeda@hidrobalt.lt

KAUNAS • Terminalo g. 3, Biruliškės, LT-54469 Kauno raj., tel. 8-37-473674, faks. 8-37-473823 el.p.: kaunas@hidrobalt.lt

VILNIUS • Savanorių pr. 151, LT-03150 Vilnius, tel. 8-5-2195307, faks. 8-5-2195306, el.p.: vilnius@hidrobalt.lt

Imonė įregistruota LR Ūkio ministerijoje 1995-11-30, Nr. BĮ 95-475. Imonės kodas 110721512, PVM kodas LT107215113

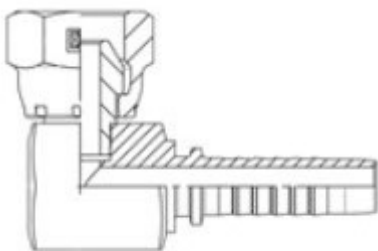

Hydraulic DKR 90 BSP threaded compact fittings
Cone - 60°
Standard - BS 5200
* - not stock

BSP thread		Hose inner diameter			Fitting code
in	dash	mm	in	dash	
1/4	04	6.4	1/4	04	P029-04
3/8	06	7.9	5/16	05	P029-06-05*
3/8	06	9.5	3/8	06	P029-06
1/2	08	9.5	3/8	06	P029-08-06*
1/2	08	12.7	1/2	08	P029-08
3/4	12	19	3/4	12	P029-12*
1	16	25.4	1	16	P029-16

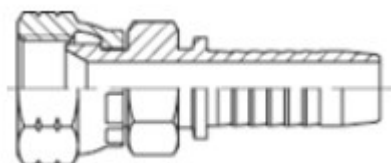

Hydraulic Toyota BSP threaded fittings
Inner Y form cone – 60°
Standard – JIS 8363
*- not stock

BSP thread		Hose inner diameter			Fitting code
in	dash	mm	in	dash	
1/8	02	3	1/8	02	P210-02
1/8	02	6	1/4	04	P210-02-04
1/4	04	6	1/4	04	P210-04
1/4	04	8	5/16	05	P210-04-05*
3/8	06	8	5/16	05	P210-06-05*
3/8	06	9.5	3/8	06	P210-06
1/2	08	12.7	1/2	08	P210-08
3/4	12	19	3/4	12	P210-12*
1	16	25.4	1	16	P210-16*
1 1/4	20	32	1 1/4	20	P210-20*
1 1/2	24	38	1 1/2	24	P210-24*

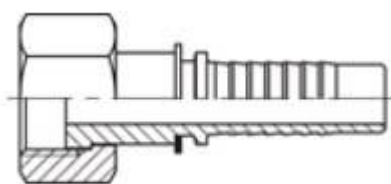

Hydraulic DKF FD BSP threaded fittings

Flat seat

Standard – ISO 228-1

*- not stock

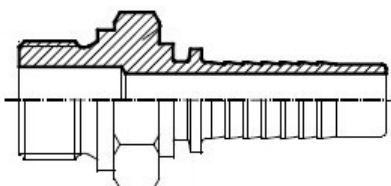

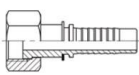
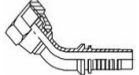
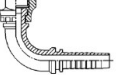
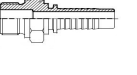
BSP thread		Hose inner diameter			Fitting code			
					P030	P034	P039	P130
in	dash	mm	in	dash				
1/4	04	6.3	1/4	04	P030-04	P034-04*	P039-04	P130-04*
3/8	04	6.3	1/4	04	P030-06-04*			P130-06-04*
		8	5/16	05	P030-06-05*			P130-06-05*
		9.5	3/8	06	P030-06	P034-06*	P039-06	P130-06*
1/2	08	8	5/16	05	P030-08-05			P130-08-05*
		9.5	3/8	06	P030-08-06			P130-08-06*
		12.7	1/2	08	P030-08	P034-08*	P039-08	P130-08*
5/8	10	12.7	1/2	08	P030-10-08*			
		16	5/8	10	P030-10	P034-10*	P038-10	P130-10*
3/4	12	12.7	1/2	08	P030-12-08			P130-12-08*
		16	5/8	10	P030-12-10			P130-12-10*
		19	3/4	12	P030-12	P034-12*	P038-12	P130-12*
1	16	19	3/4	12	P030-16-12			P130-16-12*
		25.4	1	16	P030-16	P034-16*	P039-16*	P130-16*
1 1/4	20	25.4	1	16	P030-20-16			
		32	1 1/4	20	P030-20*	P034-20*	P039-20*	
1 1/2	24	38	1 1/2	24	P030-24			
2	32	50.8	2	32	P030-32*			

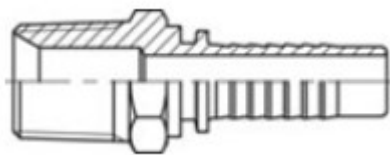

Hydraulic AGK-K BSPT male tapered fittings

Sealing thread

Standard – BS 5200 (ISO 228-1)

*-not stock

BSPT thread in-TPI	Hose inner diameter			Fitting code
	mm	in	dash	
1/8-28	4.8	3/16	03	P150-02-03*
	6.4	1/4	04	P150-02-04
1/4-19	6.4	1/4	04	P150-04
	7.9	5/16	05	P150-04-05*
	9.5	3/8	06	P150-04-06
3/8-19	6.4	1/4	04	P150-06-04
	7.9	5/16	05	P150-06-05*
	9.5	3/8	06	P150-06
	12.7	1/2	08	P150-06-08*
1/2-14	9.5	3/8	06	P150-08-06*
	12.7	1/2	08	P150-08*
	15.9	5/8	10	P150-08-10*
3/4-14	15.9	5/8	10	P150-12-10*
	19	3/4	12	P150-12*
	25.4	1	16	P150-12-16*
1-11	19	3/4	12	P150-16-12*
	25.4	1	16	P150-16*
1 1/4-11	31.8	1 1/4	20	P150-20*
1 1/2-11	38.1	1 1/2	24	P150-24*
2-11	50.8	2	32	P150-32*

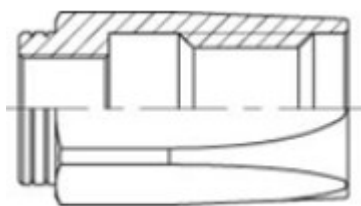

Assemble ferrules for hydraulic not skive hoses 1SN and 2SN

Hose inner diameter			Ferrule code for hose 1SN	Ferrule code for hose 2SN
mm	in	dash		
3.2	1/8	02		K2T-02
6.4	1/4	04	K1T-04*	K2T-04
9.5	3/8	06	K1T-06*	K2T-06
12.7	1/2	08	K1T-08*	K2T-08
15.9	5/8	10	K1T-10*	K2T-10
19	3/4	12	K1T-12*	K2T-12
25.4	1	16	K1T-16*	K2T-16

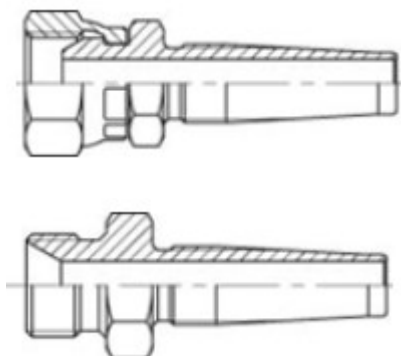

Assemble hydraulic BSP threaded fittings

*- not stock

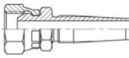
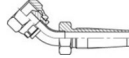
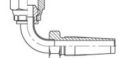
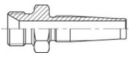
BSP thread		Hose inner diameter			Fitting code			
					K010	K014	K019	K120
in	dash	mm	in	dash				
1/4	04	6.4	1/4	04	K010-04	K014-04*	K019-04*	K120-04
3/8	06	9.5	3/8	06	K010-06	K014-06	K019-06	K120-06
1/2	08	9.5	3/8	06	K010-08-06*	K014-08-06*	K019-08-06*	K120-08-06*
1/2	08	12.7	1/2	08	K010-08	K014-08	K019-08	K120-08
5/8	10	15.9	5/8	10	K010-10	K014-10*	K019-10*	K120-10*
3/4	12	19	3/4	12	K010-12	K014-12*	K019-12*	K120-12*
1	16	25.4	1	1	K010-16*	K014-16*	K019-16*	K120-16*

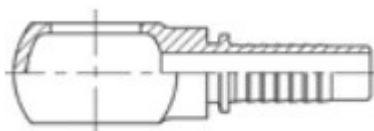

Hydraulic RNR fittings-banjo with inches hole

Standard – DIN7642

*-not stock

Screw BSP thread, in	Banjo inner diameter	Hose inner diameter			Fitting code
		mm	in	dash	
1/8	10.1	6.4	1/4	04	P800-02-04*
1/4	13.3	6.4	1/4	04	P800-04
3/8	16.7	6.4	1/4	04	P800-06-04*
3/8	16.7	7.9	5/16	05	P800-06-05*
3/8	16.7	9.5	3/8	06	P800-06
1/2	21.0	9.5	3/8	06	P800-08-06
3/8	16.7	12.7	1/2	08	P800-06-08*
1/2	21.0	12.7	1/2	08	P800-08
5/8	23.0	15.9	5/8	10	P800-10*
3/4	26.5	19.0	3/4	12	P800-12*
1	33.3	25.4	1	16	P800-16*

Screw for banjo (BSP thread)

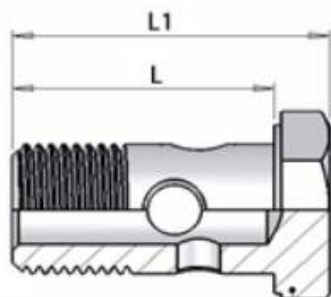

Thread, in	L	L1	Code
	mm	mm	
1/8	19	25	P810-02*
1/4	26	32	P810-04
3/8	28	34	P810-06
1/2	38	45	P810-08
3/4	45	52	P810-12*
1	62	69	P810-16*

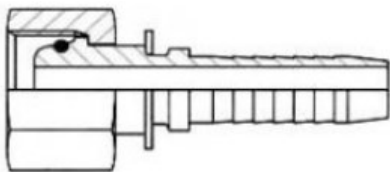

Pressure hydraulic fittings DKOL and CEL
 Cone – 24°
 DKOL standard – DIN 3865
 CEL standard – DIN 3853
 *- not stock

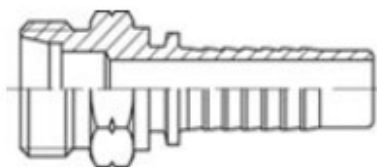

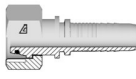
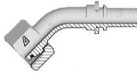
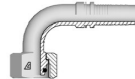
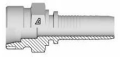
Metric thread	Hose inner diameter			Fitting code			
	mm	in	dash	P780	P784	P789	P690
							
M12x1.5	4.8	3/16	03	P780-06-03*	P784-06-03*	P789-06-03	P690-06-03*
	6.4	1/4	04	P780-06-04	P784-06-04	P789-06-04	P690-06-04
M14x1.5	4.8	3/16	03	P780-08-03*			
	6.4	1/4	04	P780-08-04	P784-08-04	P789-08-04	P690-08-04
	7.9	5/16	05	P780-08-05*	P784-08-05*		
M16x1.5	6.4	1/4	04	P780-10-04	P784-10-04	P789-10-04	P690-10-04
	7.9	5/16	05	P780-10-05	P784-10-05	P789-10-05	P690-10-05
	9.5	3/8	06	P780-10-06	P784-10-06	P789-10-06	P690-10-06
M18x1.5	6.4	1/4	04	P780-12-04		P789-12-04	P690-12-04
	7.9	5/16	05	P780-12-05	P784-12-05*	P789-12-05	P690-12-05
	9.5	3/8	06	P780-12-06	P784-12-06	P789-12-06	P690-12-06
	12.7	1/2	08	P780-12-08*	P784-12-08*	P789-12-08*	P690-12-08*
M22x1.5	9.5	3/8	06	P780-15-06		P789-15-06	P690-15-06
	12.7	1/2	08	P780-15-08	P784-15-08	P789-15-08	P690-15-08
	15.9	5/8	10	P780-15-10*		P789-15-10*	
	19	3/4	12	P780-15-12*			
M26x1.5	12.7	1/2	08	P780-18-08		P789-18-08*	P690-18-08
	15.9	5/8	10	P780-18-10	P784-18-10	P789-18-10	P690-18-10
	19	3/4	12	P780-18-12*	P784-18-12*	P789-18-12*	
M30x2	19	3/4	12	P780-22-12	P784-22-12	P789-22-12	P690-22-12
	25.4	1	16	P780-22-16*	P784-22-16*	P789-22-16*	
M36x2	19	3/4	12	P780-28-12*		P789-28-12*	
	25.4	1	16	P780-28-16	P784-28-16	P789-28-16	P690-28-16
M45x2	25.4	1	16	P780-35-16*			
	31.8	1 1/4	20	P780-35-20	P784-35-20	P789-35-20	P690-35-20*
M52x2	38.1	1 1/2	24	P780-42-24	P784-42-24	P789-42-24	P690-42-24*

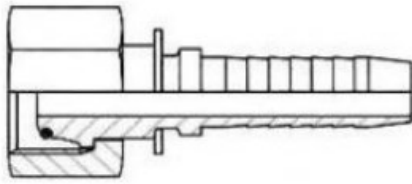

Pressure hydraulic fittings DKS and CES
 Cone – 24°
 DKS standard – DIN 3865
 CES standard – DIN 3853
 *-not stock

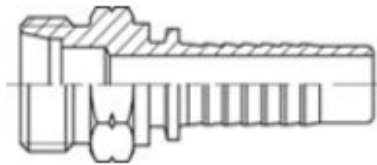

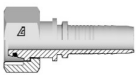
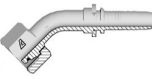
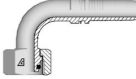
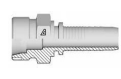
Metric thread	Hose inner diameter			Fitting code			
	mm	ini	dash	P770	P774	P779	P700
M14x1.5	6.4	1/4	04				
M16x1.5	4.8	3/16	03	P770-08-03*			
	6.4	1/4	04	P770-08-04	P774-08-04*	P779-08-04	P700-08-04
M18x1.5	9.5	3/8	06	P770-08-06*	P774-08-06*	P779-08-06*	
	6.4	1/4	04	P770-10-04	P774-10-04	P779-10-04	P700-10-04
	7.9	5/16	05	P770-10-05	P774-10-05*	P779-10-05	P700-10-05*
M20x1.5	9.5	3/8	06	P770-10-06	P774-10-06	P779-10-06	P700-10-06
	6.4	1/4	04	P770-12-04*		P779-12-04	
	7.9	5/16	05	P770-12-05	P774-12-05*	P779-12-05	P700-12-05
M22x1.5	9.5	3/8	06	P770-12-06	P774-12-06	P779-12-06	P700-12-06
	12.7	1/2	08	P770-12-08	P774-12-08*	P779-12-08	
	9.5	3/8	06	P770-14-06	P774-14-06	P779-14-06	P700-14-06
M24x1.5	12.7	1/2	08	P770-14-08	P774-14-08	P779-14-08	P700-14-08
	15.9	5/8	10	P770-16-06			
	12.7	1/2	08	P770-16-08	P774-16-08	P779-16-08	P700-16-08
M30x2	15.9	5/8	10	P770-16-10	P774-16-10	P779-16-10	
	12.7	1/2	08	P770-20-08		P779-20-08*	
	15.9	5/8	10	P770-20-10	P774-20-10	P779-20-10	P700-20-10
	19	3/4	12	P770-20-12	P774-20-12	P779-20-12	P700-20-12
M36x2	25.4	1	16	P770-20-16*			
	19	3/4	12	P770-25-12	P774-25-12	P779-25-12	P700-25-12
M42x2	25.4	1	16	P770-25-16	P774-25-16*	P779-25-16	P700-25-16
	25.4	1	16	P770-30-16	P774-30-16	P779-30-16	P700-30-16
M52x2	31.8	1 1/4	20	P770-30-20*		P779-30-20	
	31.8	1 1/4	20	P770-38-20	P774-38-20*	P779-38-20	P700-38-20*
	38.1	1 1/2	24	P770-38-24*			

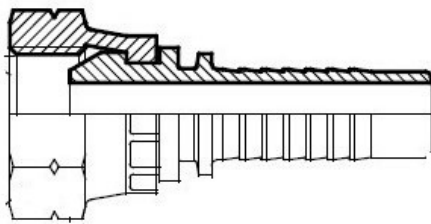

Pressure hydraulic fittings DKM

Cone – 60°

*-not stock

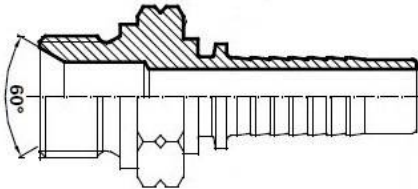

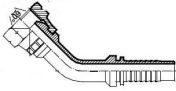
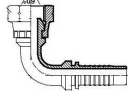
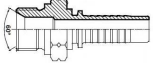
Metric thread	Hose inner diameter			Fitting code			
	mm	in	dash	P750	P754	P759	P710
M10x1	4.8	3/16	03				
	6.4	1/4	04	P750-M10x1-04*	P754-M10x1-04*	P759-M10x1-04*	P710-M10x1-04*
M12x1.5	4.8	3/16	03	P750-M12x1.5-03*	P754-M12x1.5-03*	P759-M12x1.5-03*	P710-M12x1.5-03*
	6.4	1/4	04	P750-M12x1.5-04*	P754-M12x1.5-04*	P759-M12x1.5-04*	P710-M12x1.5-04*
M14x1.5	6.4	1/4	04	P750-M14X1.5-04	P754-M14X1.5-04*	P759-M14X1.5-04	P710-M14X1.5-04
	7.9	5/16	05	P750-M14x1.5-05*	P754-M14x1.5-05*	P759-M14x1.5-05*	P710-M14x1.5-05*
M16x1.5	6.4	1/4	04	P750-M16x1.5-04*	P754-M16x1.5-04*	P759-M16x1.5-04*	P710-M16x1.5-04*
	7.9	5/16	05	P750-M16x1.5-05	P754-M16x1.5-05*	P759-M16X1.5-05	P710-M16x1.5-05*
	9.5	3/8	06	P750-M16X1.5-06	P754-M16X1.5-06*	P759-M16X1.5-06	P710-M16X1.5-06*
	12.7	1/2	08	P750-M16x1.5-08*	P754-M16x1.5-08*	P759-M16x1.5-08*	P710-M16x1.5-08*
M18x1.5	6.4	1/4	04	P750-M18x1.5-04*	P754-M18x1.5-04*	P759-M18x1.5-04*	P710-M18x1.5-04*
	7.9	5/16	05	P750-M18x1.5-05*	P754-M18x1.5-05*	P759-M18x1.5-05*	P710-M18x1.5-05*
	9.5	3/8	06	P750-M18x1.5-06	P754-M18x1.5-06*	P759-M18X1.5-06	P710-M18x1.5-06*
	12.7	1/2	08	P750-M18x1.5-08*	P754-M18x1.5-08*	P759-M18x1.5-08*	P710-M18x1.5-08*
M20x1.5	9.5	3/8	06	P750-M20x1.5-06	P754-M20x1.5-06*	P759-M20X1.5-06	P710-M20x1.5-06*
	12.7	1/2	08	P750-M20x1.5-08	P754-M20x1.5-08*	P759-M20X1.5-08	P710-M20x1.5-08*
M22x1.5	9.5	3/8	06	P750-M22x1.5-06*	P754-M22x1.5-06*	P759-M22x1.5-06*	P710-M22x1.5-06*
	12.7	1/2	08	P750-M22X1.5-08	P754-M22X1.5-08*	P759-M22X1.5-08	P710-M22X1.5-08*
M24x1.5	15.9	5/8	10	P750-M22x1.5-10*	P754-M22x1.5-10*	P759-M22x1.5-10*	P710-M22x1.5-10*
	12.7	1/2	08	P750-M24x1.5-08*	P754-M24x1.5-08*	P759-M24x1.5-08*	P710-M24x1.5-08*
M26x1.5	12.7	1/2	08	P750-M26x1.5-08*	P754-M26x1.5-08*	P759-M26x1.5-08*	P710-M26x1.5-08*
	15.9	5/8	10	P750-M26x1.5-10*	P754-M26x1.5-10*	P759-M26x1.5-10*	P710-M26x1.5-10*
	19	3/4	12	P750-M26x1.5-12*	P754-M26x1.5-12*	P759-M26x1.5-12*	P710-M26x1.5-12*
M27x1.5	15.9	5/8	10	P750-M27X1.5-10	P754-M27X1.5-10*	P759-M27X1.5-10	P710-M27X1.5-10*
	19	3/4	12	P750-M27x1.5-12*	P754-M27x1.5-12*	P759-M27x1.5-12*	P710-M27x1.5-12*
M27x2	19	3/4	12	P750-M27x2-12*	P754-M27x2-12*	P759-M27x2-12*	P710-M27x2-12*
M30x1.5	19	3/4	12	P750-M30X1.5-12	P754-M30X1.5-12*	P759-M30X1.5-12*	P710-M30X1.5-12*
M33x1.5	19	3/4	12	P750-M33X1.5-12	P754-M33X1.5-12*	P759-M33X1.5-12*	P710-M33X1.5-12*
M38x1.5	25.4	1	16	P750-M38x1.5-16*	P754-M38x1.5-16*	P759-M38x1.5-16*	P710-M38x1.5-16*
M45x1.5	31.8	1 1/4	20	P750-M45x1.5-20*	P754-M45x1.5-20*	P759-M45x1.5-20*	P710-M45x1.5-20*
M52x1.5	38.1	1 1/2	24	P750-M52x1.5-24*	P754-M52x1.5-24*	P759-M52x1.5-24*	P710-M52x1.5-24*

ALYTUS • Ulonų g. 33, LT-62161 Alytus, tel. 8-315-75075, tel. 8-315-51824 (parduotuvė), faks. 8-315-73076, el.p.: info@hidrobalt.lt

KLAIPĖDA • Dubysos g. 25, LT-91181 Klaipėda, tel. 8-46-344480, faks. 8-46-345976, klaipeda@hidrobalt.lt

KAUNAS • Terminalo g. 3, Biruliškės, LT-54469 Kauno raj., tel. 8-37-473674, faks. 8-37-473823 el.p.: kaunas@hidrobalt.lt

VILNIUS • Savanorių pr. 151, LT-03150 Vilnius, tel. 8-5-2195307, faks. 8-5-2195306, el.p.: vilnius@hidrobalt.lt

Imonė įregistruota LR Ūkio ministerijoje 1995-11-30, Nr. BĮ 95-475. Imonės kodas 110721512, PVM kodas LT107215113

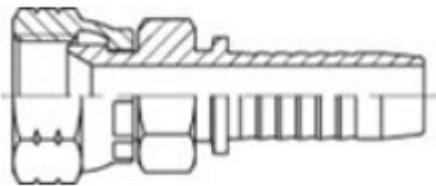

Pressure metric thread fittings Komatsu
 Cone inner form Y – 60°
 Standard – JIS8363
 *-not stock

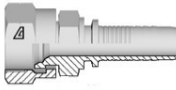
Metric thread	Hose inner diameter			Fitting code
	mm	in	dash	P260
				
M14X1.5	6.4	1/4	04	P260-14-04
	9.5	3/8	06	
M16X1.5	6.4	1/4	04	P260-16-04
	7.9	5/16	05	P260-16-05
M18X1.5	9.5	3/8	06	P260-18-06
M20X1.5	9.5	3/8	06	P260-20-06
	12.7	1/2	08	P260-20-08
M22X1.5	12.7	1/2	08	P260-22-08
M24X1.5	15.9	5/8	10	P260-24-10*
M30X1.5	19.0	3/4	12	P260-30-12*
M33X1.5	25.4	1	16	P260-33-16*
M36X1.5	31.8	1 1/4	20	P260-36-20*
M42X1.5	38.1	1 1/2	24	P260-42-24*

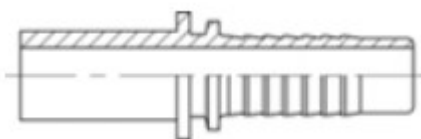

Pressure hydraulic fittings BEL/BES with tube
Standard – DIN 2353

*-not stock

Pipe outside diameter, mm	Hose inner diameter			Fitting code		
	mm	in	dash	P930	P934	P939
6	4.8	3/16	03	P930-06-03		P939-06-03*
8	4.8	3/16	03	P930-08-03*		
6	6.4	1/4	04	P930-06-04	P934-06-04	P939-06-04
8	6.4	1/4	04	P930-08-04*	P934-08-04*	P939-08-04*
10	6.4	1/4	04	P930-10-04*	P934-10-04*	P939-10-04*
12	6.4	1/4	04	P930-12-04*		P939-12-04*
8	7.9	5/16	05	P930-08-05*		
10	7.9	5/16	05	P930-10-05*	P934-10-05*	P939-10-05*
12	7.9	5/16	05	P930-12-05*	P934-12-05*	P939-12-05*
10	9.5	3/8	06	P930-06	P934-10-06*	P939-10-06*
12	9.5	3/8	06	P930-12-06	P934-12-06	P939-12-06
14	9.5	3/8	06	P930-14-06*	P934-14-06*	P939-14-06*
15	9.5	3/8	06	P930-15-06*		
10	12.7	1/2	08	P930-10-08*		
12	12.7	1/2	08	P930-12-08*	P934-12-08*	P939-12-08*
14	12.7	1/2	08	P930-14-08*		
15	12.7	1/2	08	P930-15-08	P934-15-08	P939-15-08
16	12.7	1/2	08	P930-16-08*	P934-16-08*	P939-16-08*
18	12.7	1/2	08	P930-18-08*	P934-18-08*	P939-18-08*
18	15.9	5/8	10	P930-18-10		P939-18-10
20	15.9	5/8	10	P930-20-10*		P939-20-10*
22	15.9	5/8	10	P930-22-10*		P939-22-10*
20	19.0	3/4	12	P930-20-12*		P939-20-12*
22	19.0	3/4	12	P930-22-12	P934-22-12	P939-22-12
25	19.0	3/4	12	P930-25-12*	P934-25-12*	P939-25-12*
25	25.4	1	16	P930-25-16*	P934-25-16*	P939-25-16*
28	25.4	1	16	P930-28-16*		P939-28-16*
30	25.4	1	16	P930-30-16*	P934-30-16*	P939-30-16*
38	25.4	1	16	P930-38-16*		
30	31.8	1 1/4	20	P930-35-20*		
35	31.8	1 1/4	20	P930-35-20*		P939-35-20*
38	31.8	1 1/4	20	P930-38-20*		
38	38.1	1 1/2	24	P930-38-24*		
42	38.1	1 1/2	24	P930-42-24*		P939-42-24

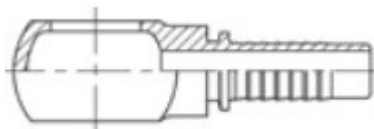

Pressures hydraulic fittings – banjo RNM with metric hole
Standard – DIN7642
*-not stock

Screw metric thread	Banjo inner diameter	Hose inner diameter			Code
		mm	in	dash	
M10x1.5	10.1	4.8	3/16	03	P800-10-03*
M10x1.5	10.1	6.4	1/4	04	P800-10-04
M12X1.5	12.1	6.4	1/4	04	P800-12-04
M14X1.5	14.1	6.4	1/4	04	P800-14-04
M12X1.5	12.1	7.9	5/16	05	P800-12-05
M14X1.5	14.1	7.9	5/16	05	P800-14-05
M16X1.5	16.1	7.9	5/16	05	P800-16-05
M18X1.5	18.1	7.9	5/16	05	P800-18-05
M14X1.5	14.1	9.5	3/8	06	P800-14-06
M16X1.5	16.1	9.5	3/8	06	P800-16-06
M18X1.5	18.1	9.5	3/8	06	P800-18-06
M18X1.5	18.1	12.7	1/2	08	P800-18-08
M20X1.5	20.1	9.5	3/8	06	P800-20-06
M20X1.5	20.1	12.7	1/2	08	P800-20-08
M22X1.5	22.1	9.5	3/8	06	P800-22-06
M22X1.5	22.1	12.7	1/2	08	P800-22-08
M22X1.5	22.1	15.9	5/8	10	P800-22-10
M26X1.5	26.1	15.9	5/8	10	P800-26-10
M26X1.5	26.1	19.0	3/4	12	P800-26-12
M30X1.5	30.1	25.4	1	16	P800-30-16*

Screw for banjo (metric thread)

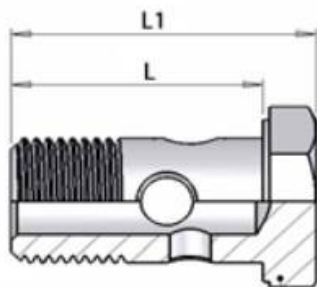

Metric thread	L	L1	Code
	mm	mm	
M10x1	19	25	HS-04
M12x1.5	24	30	HS-06
M14x1.5	26	32	HS-08
M16x1.5	28	34	HS-10
M18x1.5	32	38	HS-13
M22x1.5	39	46	HS-17
M26x1.5	45	52	HS-19*
M30x1.5	55	62	HS-21*

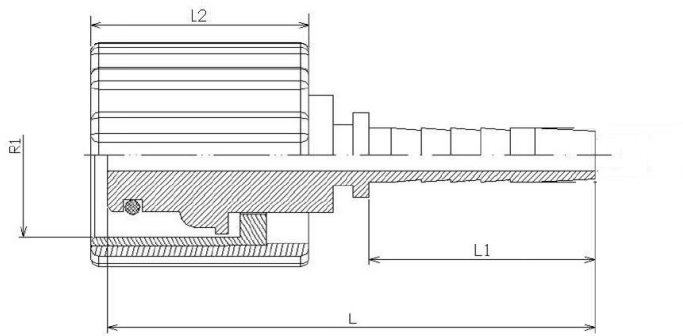

Pressure hydraulic fittings for high pressure washing (Karcher)

Metric thread R1	L	L1	L2	Hose inner diameter			Fitting code
	mm			mm	mm	in	
M22X1.5	60.5	28	20	6.4	1/4	04	P280-14-04
M22X1.5	61	28	20	7.9	5/16	05	P280-14-05
M22X1.5	62.5	29.5	20	9.5	3/8	06	P280-14-06
M22X1.5	60.5	28	25	6.4	1/4	04	P282-14-04
M22X1.5	61	28	25	7.9	5/16	05	P282-14-05
M22X1.5	62.5	29.5	25	9.5	3/8	06	P282-14-06

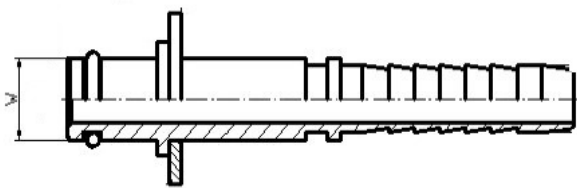

Pressure fittings-tube for high pressure washing
*-not stock

Pipe outside diameter W, mm	Hose inner diameter			Fitting code
	mm	in	dash	
10	6.4	1/4	04	P290-04
10	7.9	5/16	05	P290-05
10	9.5	3/8	06	P290-06
10	12.7	1/2	08	P290-08
11	6.4	1/4	04	P290-04-3
11	7.9	5/16	05	P290-05-3
11	9.5	3/8	06	P290-06-3*
11	12.7	1/2	08	P290-08-3*

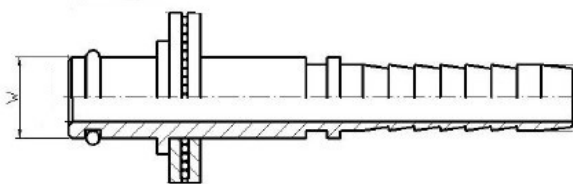

Pressure fittings-tube for high pressure washing with bearing
*-not stock

Pipe outside diameter W, mm	Hose inner diameter			Fitting code
	mm	in	dash	
11	6.4	1/4	04	P290-04-GUOL
11	7.9	5/16	06	P290-05-GUOL
11	9.5	3/8	06	P290-06-GUOL*
11	12.7	1/2	08	P290-08-GUOL*

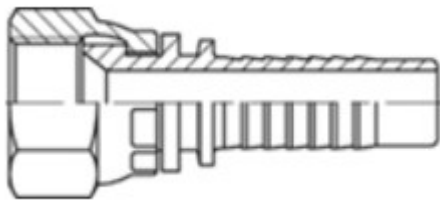

Pressure hydraulic fittings DKJ and AGJ with inches JIC thread
Cone – 37°
Standard – SAEJ514
*-not stock

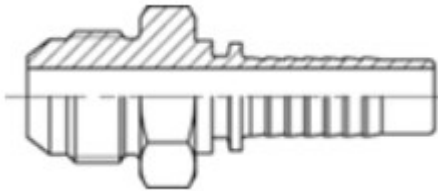

JIC thread	Hose inner diameter			Fitting code			
				P050	P054	P059	P180
In-TPI	mm	in	dash				
7/16-20	4.8	3/16	03	P050-04-03*	P051-04-03*	P059-04-03*	P180-04-03*
7/16-20	6.4	1/4	04	P050-04	P054-04	P059-04	P180-04
1/2-20	6.4	1/4	04	P050-05-04	P054-05-04*	P059-05-04	P180-05-04
9/16-18	6.4	1/4	04	P050-06-04	P054-06-04	P059-06-04	P180-06-04
1/2-20	7.9	5/16	05	P050-05*	P054-05*		P180-05*
9/16-18	7.9	5/16	05	P050-06-05	P054-06-05*	P059-06-05	P180-06-05*
9/16-18	9.5	3/8	06	P050-06	P054-06	P059-06	P180-06
3/4-16	9.5	3/8	06	P050-08-06	P054-08-06	P059-08-06	P180-08-06
7/8-14	9.5	3/8	06	P050-10-06			P180-10-06*
3/4-16	12.7	1/2	08	P050-08	P054-08	P059-08	P180-08
7/8-14	12.7	1/2	08	P050-10-08	P054-10-08	P059-10-08	P180-10-08
1 1/16-12	12.7	1/2	08	P050-12-08		P059-12-08*	P180-12-08*
7/8-14	15.9	5/8	10	P050-10	P054-10	P059-10	P180-10
1 1/16-12	15.9	5/8	10	P050-12-10	P050-12-10*	P059-12-10	P180-12-10
7/8-14	19.0	3/4	12	P050-10-12*			
1 1/16-12	19.0	3/4	12	P050-12	P054-12	P059-12	P180-12
1 3/16-12	19.0	3/4	12	P050-14-12	P054-14-12*	P059-14-12*	P180-14-12*
1 5/16-12	19.0	3/4	12	P050-16-12	P054-16-12*	P059-16-12	P180-16-12
1 1/16-12	25.4	1	16	P050-12-16*			P180-12-16*
1 5/16-12	25.4	1	16	P050-16	P054-16	P059-16	P180-16
1 5/8-12	25.4	1	16	P050-20-16	P054-20-16*		P180-20-16
1 5/16-12	31.8	1	20	P050-16-20*			
1 5/8-12	31.8	1 1/4	20	P050-20	P054-20*		P180-20*
1 7/8-12	31.8	1 1/4	20	P050-24-20*			P180-24-20*
1 7/8-12	38.1	1 1/2	24	P050-24			P180-24*
1 7/8-12	50.8	2	32	P050-24-32			P180-24-32*

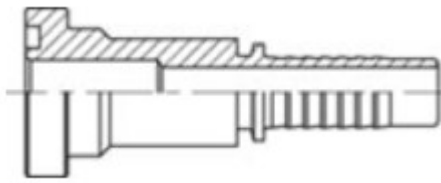

Pressure hydraulic fittingsi SFL flange, SAE 3000 PSI
 Flat seat
 Standards – SAE 3000 PSI, ISO 6162
 *- not stock

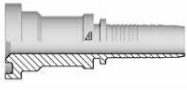
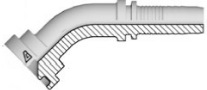
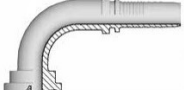
Flange outher diameter	Hose inner diameter			Fitting code		
				P380	P384	P389
mm	mm	in	dash			
30.2	12.7	1/2	08	P380-08	P384-08*	P389-08
38.1	12.7	1/2	08	P380-12-08*	P384-12-08*	
38.1	15.9	5/8	10	P380-12-10	P384-12-10	P389-12-10
38.1	19.0	3/4	12	P380-12	P384-12	P389-12
44.5	19.0	3/4	12	P380-16-12	P384-16-12	P389-16-12
44.5	25.4	1	16	P380-16	P384-16	P389-16
50.8	25.4	1	16	P380-20-16	P384-20-16	P389-20-16
60.3	25.4	1	16	P380-24-16*	P384-24-16*	P389-24-16*
44.5	31.8	1 1/4	20	P380-16-20	P384-16-20*	P389-16-20*
50.8	31.8	1 1/4	20	P380-20	P384-20	P389-20
60.3	31.8	1 1/4	20	P380-24-20	P384-24-20	P389-24-20
60.3	38.1	1 1/2	24	P380-24	P384-24	P389-24
71.4	38.1	1 1/2	24	P380-32-24*	P384-32-24*	P389-32-24*
60.3	50.8	2	32	P380-24-32*	P384-24-32*	P389-24-32*
71.4	50.8	2	32	P380-32*	P384-32*	P389-32*
71.4	63.5	2 1/2	40	P380-32-40*		P389-32-40*
84.1	50.8	2	32	P380-40-32*	P384-48-40*	P389-48-40*
84.1	63.5	2 1/2	40	P380-40*		
101.6	76.2	3	48	P380-48*		
127	101	4	64	P380-64*		

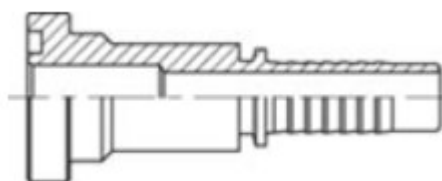

Pressure hydraulic fittingsi SFS flange, SAE 6000 PSI

Flat seal

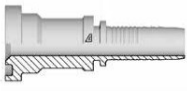
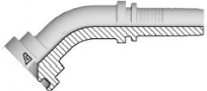
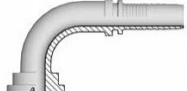

Standards – SAE 6000 PSI, ISO 6162

*- not stock

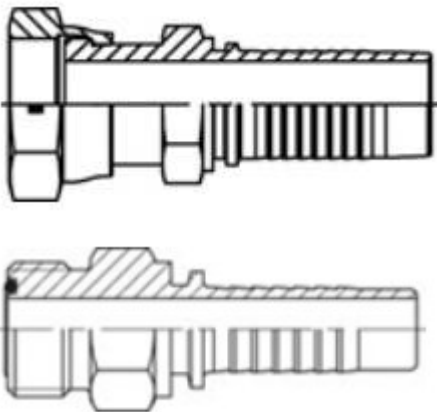
Flange outer diameter	Hose inner diameter			Fitting code		
				P680	P684	P689
mm	mm	in	dash			
31.8	12.7	1/2	08	P680-08	P684-08	P689-08
41.3	12.7	1/2	08	P680-12-08*	P684-12-08*	P689-12-08*
31.8	15.9	5/8	10	P680-08-10		P689-08-10
31.8	19.0	3/4	12	P680-08-12	P684-08-12	P689-08-12
41.3	15.9	5/8	10	P680-12-10	P684-12-10	P689-12-10
47.6	15.9	5/8	10	P680-16-10*		P689-16-10*
41.3	19.0	3/4	12	P680-12	P684-12	P689-12
47.6	19.0	3/4	12	P680-16-12	P684-16-12	P689-16-12
41.3	25.4	1	16	P680-12-16*		P689-12-16*
47.6	25.4	1	16	P680-16	P684-16	P689-16
54	25.4	1	16	P680-20-16	P684-20-16*	P689-20-16
54	31.8	1 1/4	20	P680-20	P684-20	P689-20
63.5	31.8	1 1/4	20	P680-24-20	P684-24-20*	P689-24-20*
54	38.1	1 1/4	20	P680-20*	P684-20*	P689-20*
63.5	38.1	1 1/2	24	P680-24*	P684-24*	P689-24*
79.4	38.1	1 1/2	24	P680-32-24*	P684-32-24*	P689-32-24*
79.4	50.8	2	32	P680-32*	P684-32*	P689-32*

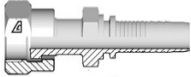
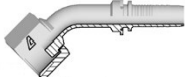
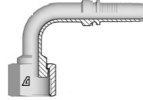

Pressure hydraulic fittings ORFS thread UN/UNF
 Flat seal
 Standard – SAE – J1453
 *-not stock

UN/UNF thread, In-TPI	Hose inner diameter			Fitting code			
				P230	P234	P239	P240
	mm	in	dash				
9/16 - 18	4.8	3/16	03	P230-04-03*			
	6.4	1/4	04	P230-04	P234-04*	P239-04	P240-04
	9.5	3/8	06	P230-04-06*			
11/16 - 16	6.4	1/4	04	P230-06-04	P234-06-04*	P239-06-04	P240-06-04*
	7.9	5/16	05	P230-06-05	P234-06-05*	P239-06-05	
	9.5	3/8	06	P230-06	P234-06	P239-06	P240-06
	12.7	1/2	08	P230-06-08*			
13/16 - 16	6.4	1/4	04	P203-08-04*			
	9.5	3/8	06	P230-08-06	P234-08-06*	P239-08-06	P240-08-06
	12.7	1/2	08	P230-08	P234-08	P239-08	P240-08
	15.9	5/8	10	P230-08-10*			
1 - 14	12.7	1/2	08	P230-10-08	P234-10-08	P239-10-08	P240-10-08
	15.9	5/8	10	P230-10	P234-10*	P239-10	P240-10
	19.0	3/4	12	P230-10-12*	P234-10-12*		P240-10-12*
1 3/16 - 12	12.7	1/2	08	P230-12-08*		P239-12-08*	P240-12-08*
	15.9	5/8	10	P230-12-10	P234-12-10*	P239-12-10	P240-12-10
	19.0	3/4	12	P230-12	P234-12	P239-12	P240-12
	25.4	1	16	P230-12-16*		P239-12-16*	
1 7/16 - 12	19.0	3/4	12	P230-16-12	P234-16-12*	P239-16-12	P240-16-12
	22.2	7/8	14	P230-16-14*			
	25.4	1	16	P230-16	P234-16	P239-16	P240-16
1 11/16 - 12	25.4	1	16	P230-20-16*	P234-20-16*	P239-20-16*	P240-20-16*
	31.8	1 1/4	20	P230-20*	P234-20*	P239-20*	P240-20*
2 - 12	31.8	1 1/4	20	P230-24-20*	P234-24-20*	P239-24-20*	
	38.1	1 1/2	24	P230-24*	P234-24*	P239-24*	